

Diamond Sign Retro Fit Kit

Contents

***NOTE:** Make sure to pre-assemble the kit before attaching it to the sign.

***NOTE:** If any part of the sign does not light up, then flip the light bar section that isn't lighting up.

***NOTE:** Prior to install make sure the solar panel has been charged in sunlight for 2 full days.



(4) Light Bar Sign Corners



(1) Key

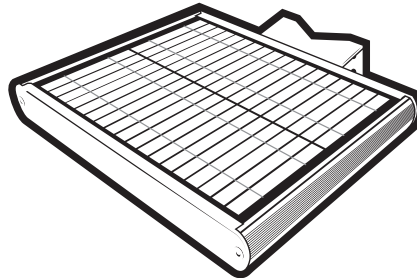

(1) Solar Panel

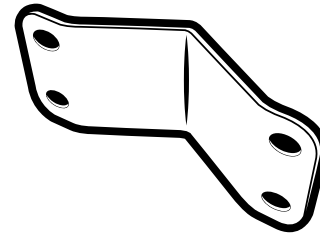

(1) Mounting Bracket



(1) Tube of Silicone

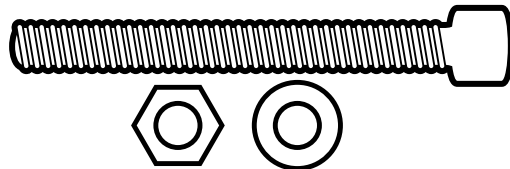

(4) Bolts, (4) Nuts, (8) Washers

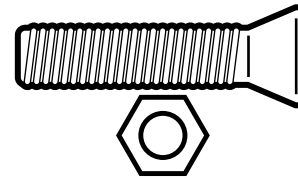

(4) Screws, (4) Nuts

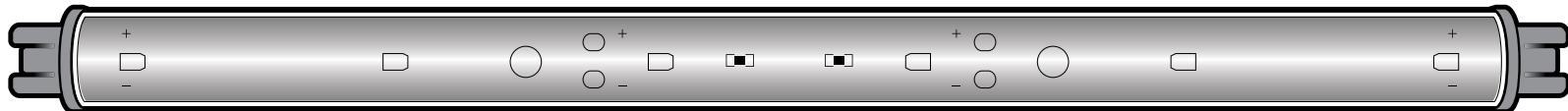

(3) Light Bars

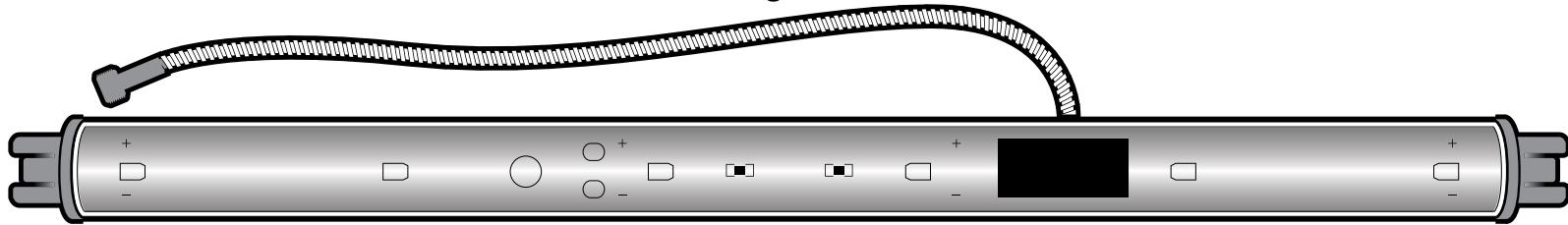

(1) Light Bar with Connector Cable

Step 1

Take Light Bar Sign corner and place it at the top of your sign where the solid black line is.

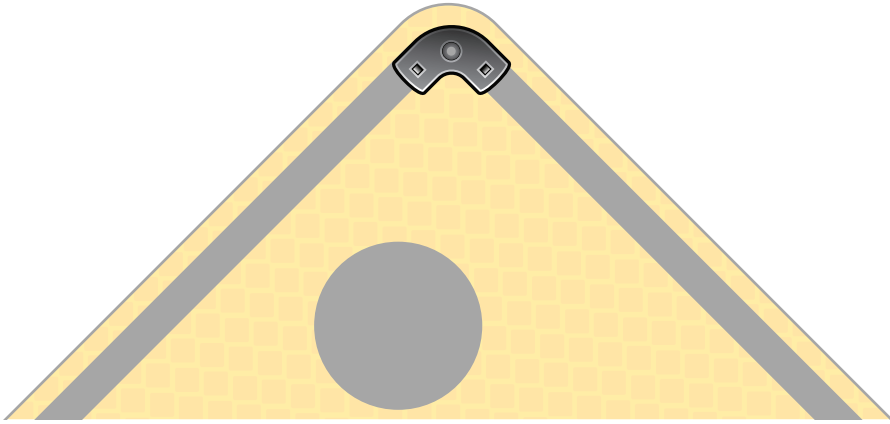

Step 2

Take the Light Bar with the connector cable and snap it into the sign corner. Then take another light bar and snap it into the opposite side.

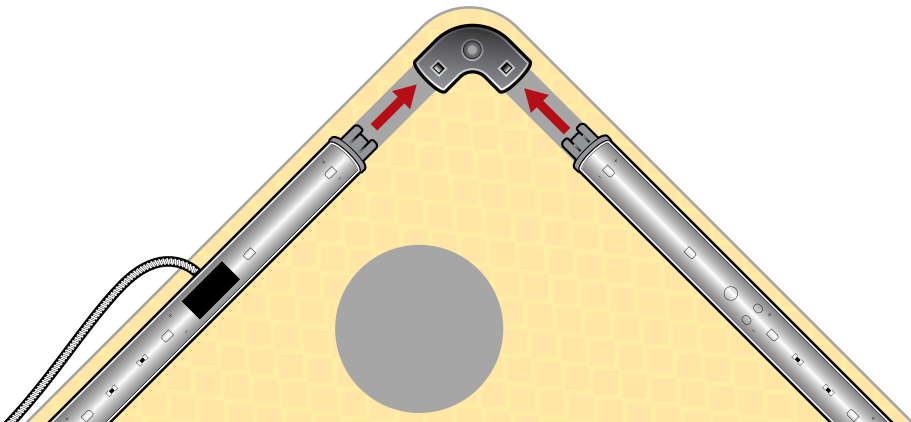

Step 3

Repeat the process until you have a completed frame. A finished sign should look like the image below.



***NOTE:** When assembling, make sure the positive sides are on the same sides throughout the entire sign.

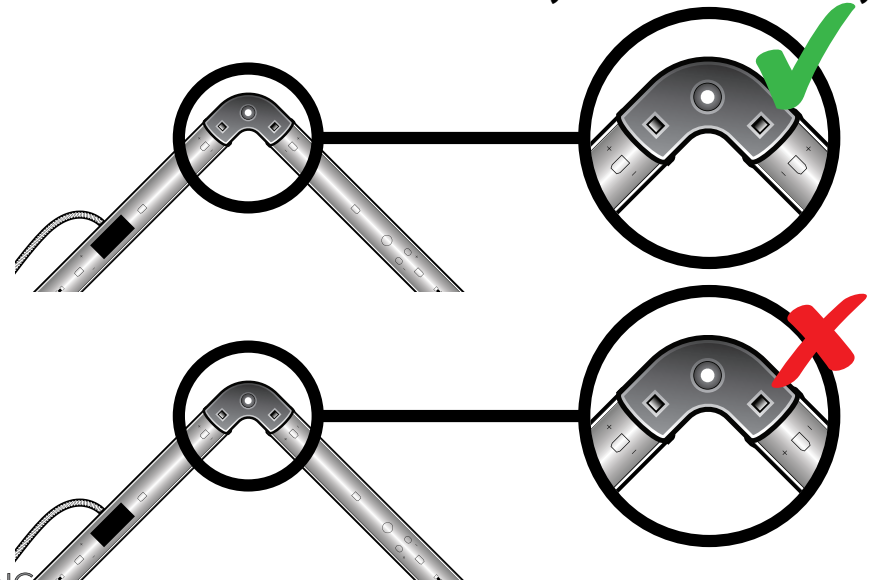

Step 4 *Optional

Take a drill and use an 1/8" drill bit and drill into each corner of the sign.

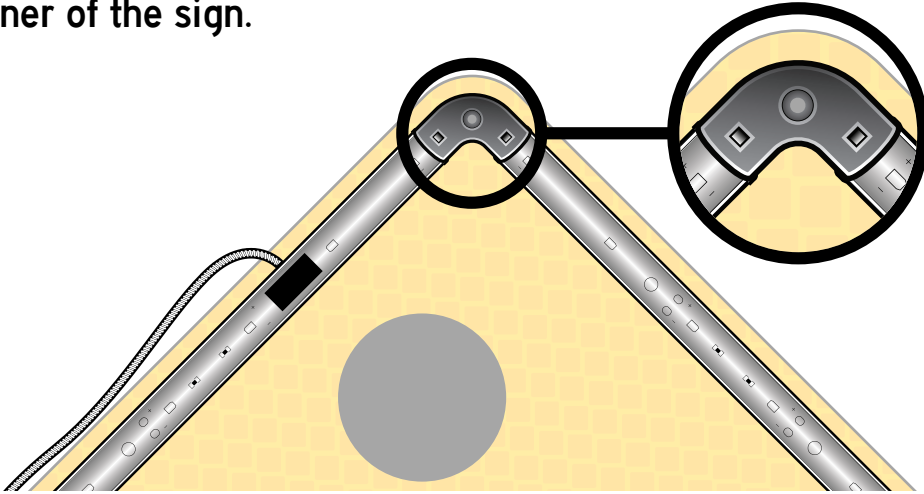

Step 6

Once the screw has been inserted, attach the nuts to the backside of the sign and tighten them down.

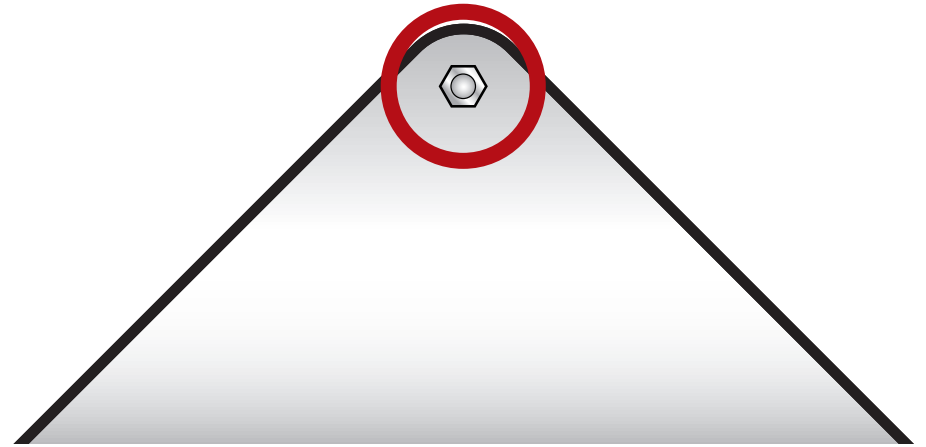

Step 5

Once the holes have been drilled, take your screws and insert them into the holes.

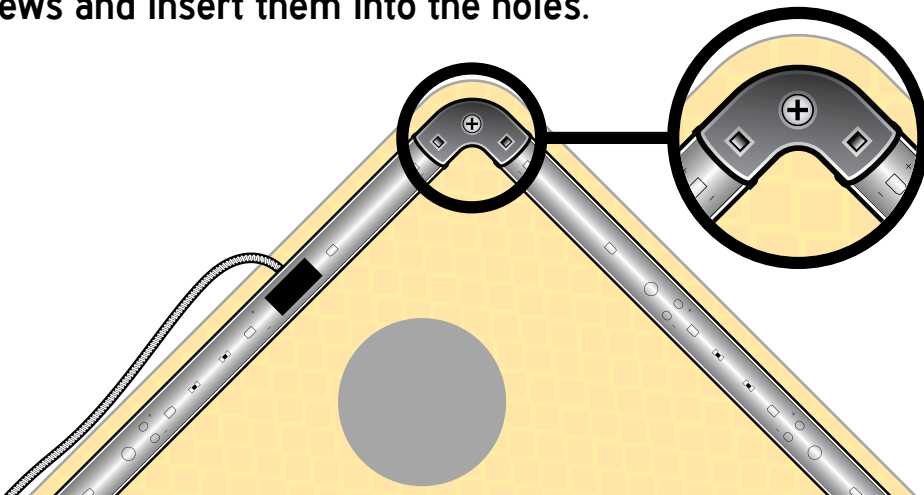

Step 7

PLEASE NOTE: MAKE SURE TO PLACE YOUR SOLAR PANEL IN FULL SUNLIGHT FOR 2 DAYS TO INSURE FULL CHARGE. YOU MUST HAVE THE PANEL IN THE "ON" POSITION TO CHARGE IT.

Once your sign is assembled, you will need to setup the solar panel for it. Take the solar panel and flip it upside down. You will see a white disk, on that disk is a tiny hole.

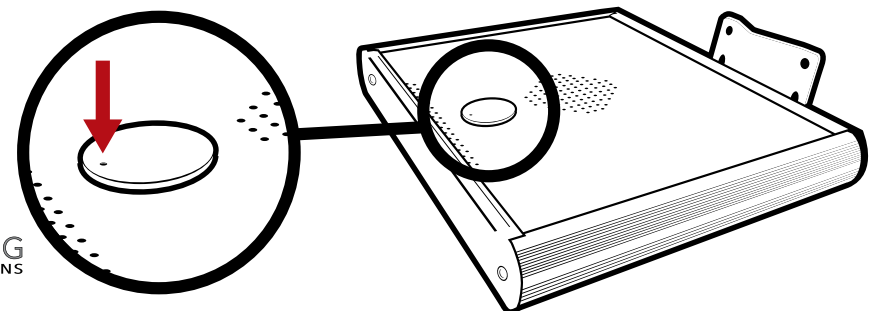

Step 8

Take the key that was provided in the kit and insert it into the hole and hold it there for 5 seconds. Once the panel is on, you will see 4 red lights flash.

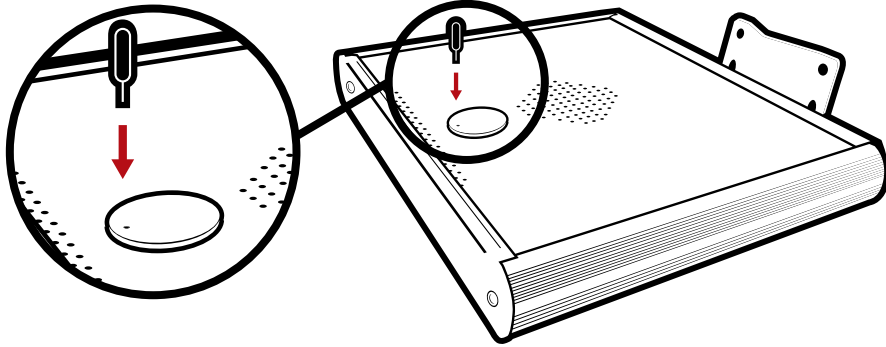

Step 9

Once the solar panel is turned on, connect the cable from the solar panel to the Light Bar Connector Cable.

